

5mm Round Hyper Red LED T-1 3/4

Technical Data Sheet

Model No : LL-503VC2E-V1

Features

- ◇ Popular T-1 3/4 diameter package
- ◇ High efficiency
- ◇ Selected minimum intensities
- ◇ General purpose leads
- ◇ Available on tape and reel
- ◇ Reliable and robust
- ◇ Pb free
- ◇ The product itself will remain within RoHS complaint Version.

Descriptions

- ◇ The series is specially designed for applications requiring higher brightness
- ◇ The LED lamps are available with different colors,intensities .

Applications

- ◇ Status indicators.
- ◇ Commercial use.
- ◇ Advertising Signs.
- ◇ Back lighting

Package Dimension:

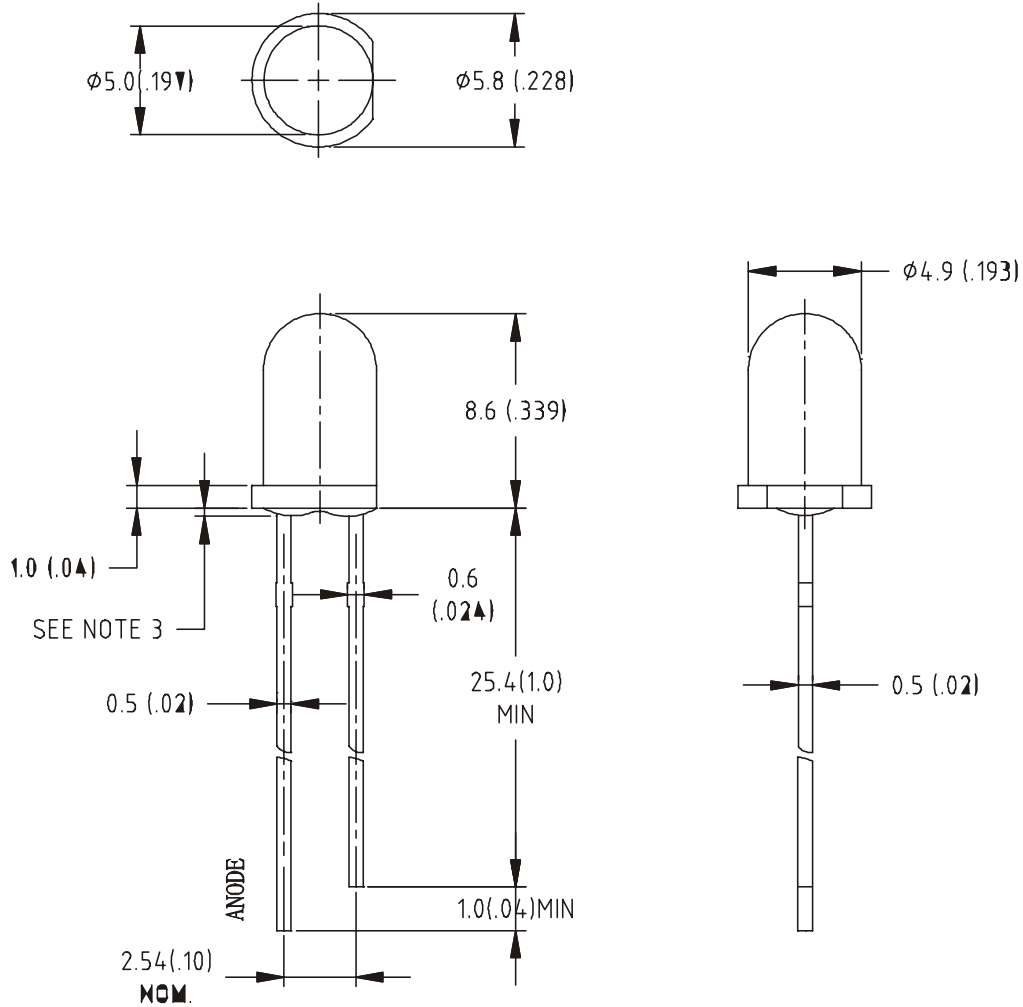

Model No.	Material	Lens Color	Source Color
LL-503VC2E-V1	InGaAlP	Water Clear	Hyper Red

Notes:

1. All dimensions are in millimeters (inches).
2. Tolerance is $\pm 0.25 (.010)$ mm unless otherwise noted.
3. Protruded resin under flange is $1.0 \text{mm} (.04)$ max
4. Specifications are subject to change without notice.

Absolute Maximum Ratings at Ta=25°C

Parameter	Symbol	MAX	Unit
Power Dissipation	PD	100	mW
Peak Forward Current (1/10 Duty Cycle, 0.1ms Pulse Width)	IFP	100	mA
Continuous Forward Current	IF	25	mA
Reverse Voltage	VR	5	V
Operating Temperature Range	Topr	-40°C to +85°C	
Storage Temperature Range	Tstg	-40°C to +100°C	
Lead Soldering Temperature [4mm(.157") From Body]	Tsld	260°C for 5 Seconds	

Electrical Optical Characteristics at Ta=25°C

Parameter	Symbol	Min.	Typ.	Max.	Unit	Test Condition	
Viewing Angle*	$2\theta_{1/2}$	---	20	---	Deg	(Note 2)	
Forward Voltage	V_F	---	2.0	2.4	V	IF =20mA	
Reverse Current	I_R	---	---	10	μA	$V_R=5V$	
Peak Emission Wavelength	λ_p	---	632	---	nm	IF =20mA	
Dominant Wavelength	λ_d	---	624	---	nm	IF =20mA	
Spectrum Radiation Bandwidth	$\Delta\lambda$	---	20	---	nm	IF =20mA	
Luminous Intensity (Note 1)*	1AC	IV	1000	1600	---	mcd	IF =20mA
	2BC		1500	2400	---		
	3BC		1950	3120	---		
	2CC		2900	4640	---		
	3CC		4000	6400	---		
	4DC		6600	10560	---		

Notes:

- Luminous Intensity Measurement allowance is $\pm 10\%$
- $\theta_{1/2}$ is the off-axis angle at which the luminous intensity is half the axial luminous intensity

Reliability

1) Test Items and Results

Test Item	Standard Test Method	Test Conditions	Note	Number of Damaged
Resistance to Soldering Heat	JEITA ED-4701 300 302	Tsld=260±5℃,10sec 3mm from the base of the epoxy bulb	1 time	0/100
Solderability	JEITA ED-4701 300 303	Tsld=235±5℃,5sec(using flux)	1time over 95%	0/100
Thermal Shock	JEITA ED-4701 300 307	0℃~100℃ 15sec,15sec	100 cycles	0/100
Temperature Cycle	JEITA ED-4701 100 105	-40℃~25℃~100℃~25℃ 30min,5min,30min,5min	100 cycles	0/100
Moisture Resistance Cyclic	JEITA ED-4701 200 203	25℃~65℃~-10℃ 90%RH 24hrs/1cycle	10 cycles	0/100
High Temperature Storage	JEITA ED-4701 200 201	Ta=100℃	1000hrs	0/100
Terminal Strength (Pull test)	JEITA ED-4701 400 401	Load 10N (1kgf) 10±1sec	Nonnoticeable damage	0/100
Terminal Strength (bending test)	JEITA ED-4701 400 401	Load 5N (0.5kgf) 0° ~90° ~0° bend 2 times	Nonnoticeable damage	0/100
Temperature Humidity Storage	JEITA ED-4701 100 103	Ta=60℃,RH=90%	1000hrs	0/100
Low Temperature Storage	JEITA ED-4701 200 202	Ta=-40℃	1000hrs	0/100
Steady State Operating Life		Ta=25℃, IF=30mA	1000hrs	0/100
Steady State Operating Life of High Humidity Heat		Ta=60℃,RH=90%,IF=30mA	500hrs	0/100
Steady State Operating Life of Low Temperature		Ta=-30℃, IF=20mA	1000hrs	0/100

2)Criteria For Judging The Damage

Item	Symbol	Test Conditions	Criteria for Judgement	
			Min	Max
Forward Voltage	VF	IF=20mA	—	F.V.*)×1.1
Reverse Current	IR	VR=5V	—	F.V.*)×2.0
Luminous Intensity	IV	IF=20mA	F.V.*)×0.7	—

*)F.V.:First Value

Typical Electrical / Optical Characteristics Curves
(25°C Ambient Temperature Unless Otherwise Noted)

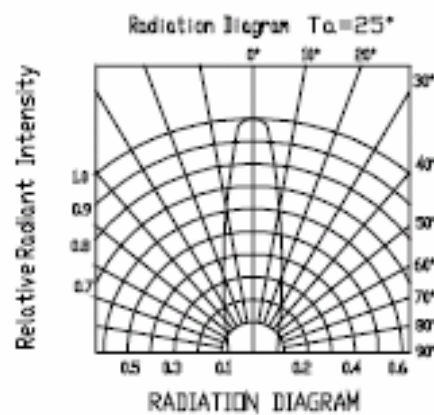
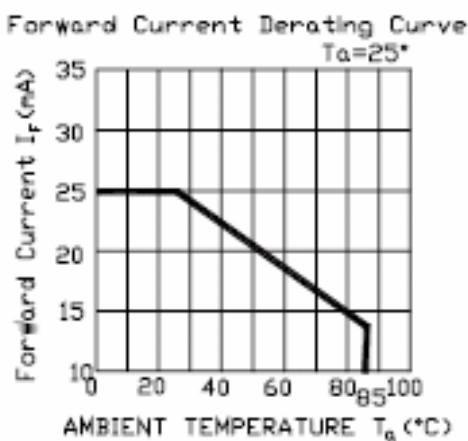
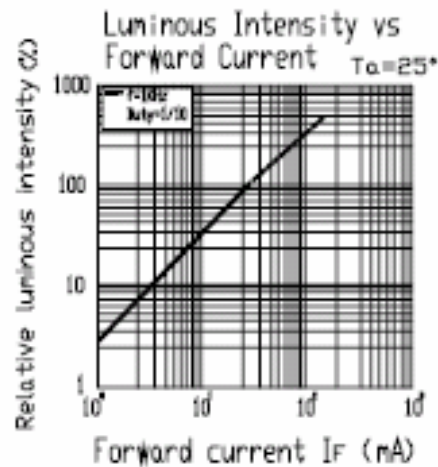
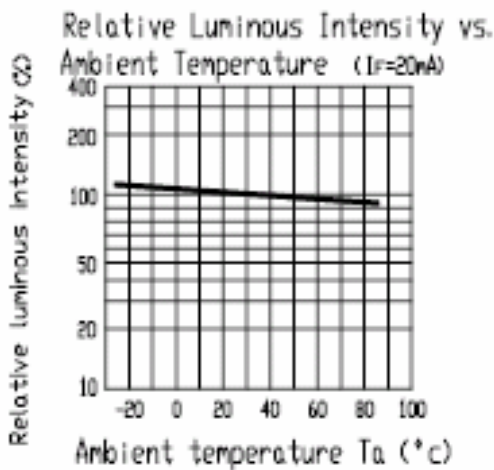
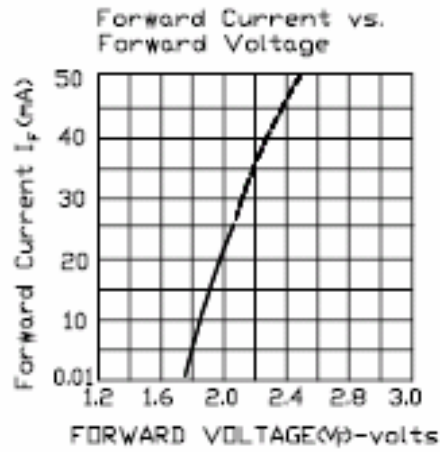
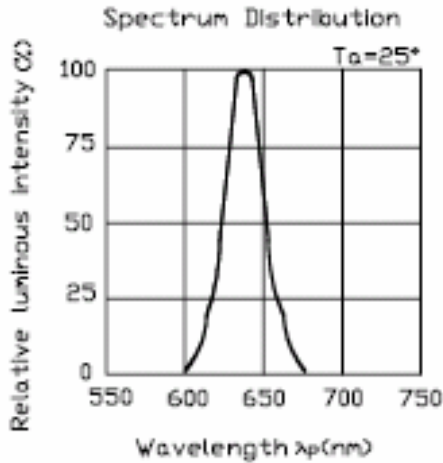

Please read the following notes before using the datasheets

1. Over-current-proof

Customer must apply resistors for protection , otherwise slight voltage shift will cause big current change (Burn out will happen).

2. Storage

2.1 Do not open moisture proof bag before the products are ready to use.

2.2 Before opening the package, the LEDs should be kept at 30°C or less and 90%RH or less.

2.3 The LEDs should be used within a year.

2.4 After opening the package, the LEDs should be kept at 30°C or less and 70%RH or less.

2.5 The LEDs should be used within 168 hours (7 days) after opening the package.

3. Soldering Condition

3.1 Pb-free solder temperature profile

3.2 Reflow soldering should not be done more than two times.

3.3 When soldering, do not put stress on the LEDs during heating.

3.4 After soldering, do not warp the circuit board.

4. Soldering Iron

Each terminal is to go to the tip of soldering iron temperature less than 260°C for 5 seconds within once in less than the soldering iron capacity 25W. Leave two seconds and more intervals, and do soldering

of each terminal. Be careful because the damage of the product is often started at the time of the hand solder.

5. Repairing

Repair should not be done after the LEDs have been soldered. When repairing is unavoidable, a double-head soldering iron should be used. It should be confirmed beforehand whether the characteristics of the LEDs will or will not be damaged by repairing.